

SINGLE-PHASE DRY-TYPE POWER TRANSFORMERS

Ref : 6M802-TN-H036

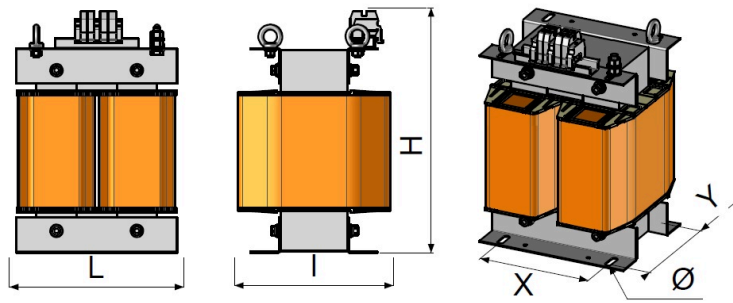

*Dimensions are expressed in millimeters, mass in kilograms and reserves represent the ventilation space to be kept around the product for good heat dissipation. The drawing is not contractual.

Notes et options

Options: Adjustment taps, Multi-voltages, Electrostatic screen, Reduced inrush current, Low consumption, Resistance to harmonics, Silent block, caster, Integrated protections, reinforced insulation, Tropicalization, Class II, transformer Factor K5, K7, K9, High frequencies.

Additional options for the covered versions: Specific color paint, IP21 to IP55, Built-in case with integrated protections, custom housing possible,

Product reference	6M802-TN-H036
Power/Value	8 KVA
IP Indice	IP00
Voltage(s)/Current	400V / 230V
Number of Phases	Single-Phase
Use frequency	50-60Hz
Dimensions (L x l x H)	240 x 227 x 362
Fixings: X x Y x Ø (mm)	180 x (130 - 170) x 10
Weight	44
Standard	IEC 60076-11
Winding material	Aluminium
RoHS compliant	Yes
Temperature rise class	Classe H
Eyebolts	Yes
Recommended Electrical Protection Input / Output	DJ D - 32A / DJ C - 32A
Dielectric Input/Output and active/ground	3000V / 3000V
Insulation class	I
Cooling	Air Naturel